

## MINI MISTRAL SURFACE

**E10W0143-** -

base number      Color      Finish  
Temperature      Options

1. To build a product code in our configurator select the specify button on the base model # product page
2. To build a manual product code on this datasheet choose from the options listed below in blue font and add the suffix to the base model #

### GENERAL

Series: Mistral  
Subseries: Mini Mistral  
Brand: Side  
Division: Exterior  
Mounting Type: Surface  
Mounting Location: Wall  
Subcategory: Up/Down Light

### PHYSICAL

Shape: Abstract  
Width (mm): 266  
Width (in): 10 1/2  
Height (mm): 141  
Height (in): 5 9/16  
Extension (mm): 138  
Extension (in): 5 1/16  
Light Distribution: Direct / Indirect  
Weight (kg): 1.8  
Weight (lbs): 3.97  
Diffuser: Frosted tempered glass  
Gasket: Silicon rubber  
Fixture Finish: WHI / BLK / GRY  
Fixture Material: Aluminum Die Cast

### ELECTRICAL

Lamp Type: LED (Zhaga Standard)  
Input Wattage (W): 22  
Total Output Wattage (W): 16  
Dimming: Non-Dimmable  
Driver Included: Yes  
Driver Location: Integrated  
Driver Type: Constant Current - Universal  
Driver Class: Class 1  
Input Voltage (V): 120 - 277  
Constant Current (MA): 350  
Upon Request: (Not included - see components [IP65 or higher enclosure to be supplied by others]) Remote: 0-10Vdc dimming / Phase dimming @120Vac only

### LED

Color Temperature (°K): 3000 / 4000  
Max. Delivered Lumen (lm): 1215.8 / 1321.5  
CRI: >80 CRI  
Lamp Life (hrs): 50000

### OPTICAL

Beam Angle: Symmetric

### RATINGS AND CERTIFICATIONS

Certified By: Certified for North American Standards  
IP rating: IP65

PROJECT	_____
TYPE	_____
SPECIFIER	_____
QUANTITY	_____
DATE	_____



## MISTRAL SURFACE

**E10W0155-** -

base number      Color      Finish  
 Temperature      Options

- To build a product code in our configurator select the specify button on the base model # product page
- To build a manual product code on this datasheet choose from the options listed below in blue font and add the suffix to the base model #

### GENERAL

Series: Mistral  
 Brand: Side  
 Division: Exterior  
 Mounting Type: Surface  
 Mounting Location: Wall  
 Subcategory: Wall Effect

### PHYSICAL

Shape: Abstract  
 Width (mm): 380  
 Width (in): 14 <sup>15</sup>/<sub>16</sub>  
 Height (mm): 193  
 Height (in): 7 <sup>5</sup>/<sub>8</sub>  
 Extension (mm): 195  
 Extension (in): 7 <sup>11</sup>/<sub>16</sub>  
 Light Distribution: Direct / Indirect  
 Weight (kg): 6  
 Weight (lbs): 13.2  
 Diffuser: Frosted tempered glass  
 Gasket: Silicon rubber  
 Fixture Finish: WHI / BLK / GRY  
 Fixture Material: Aluminum Die Cast

### ELECTRICAL

Lamp Type: LED (Zhaga Standard)  
 Input Wattage (W): 47  
 Total Output Wattage (W): 44  
 Dimming: 0-10V Dimming / Phase Dimming (120Vac Only)  
 Driver Included: Yes  
 Driver Location: Integrated  
 Driver Type: Constant Current - Universal  
 Driver Class: Class 2  
 Input Voltage (V): 120 - 277  
 Constant Current (MA): 500

Upon Request: (Not included - see components [IP65 or higher enclosure to be supplied by others]) Remote: 0-10Vdc dimming / Phase dimming @120Vac only / (Included) Integral: Non-dimming 277Vac

### LED

Color Temperature (°K): 3000 / 4000  
 Max. Delivered Lumen (lm): 2540.2 / 2857.7  
 CRI: >80 CRI  
 Efficiency (%): 99.8  
 Lamp Life (hrs): 50000

### OPTICAL

Reflector: Pure Aluminium Reflector  
 Beam Angle: Symmetric

### RATINGS AND CERTIFICATIONS

Certified By: Certified for North American Standards  
 IP rating: IP65

PROJECT	
TYPE	
SPECIFIER	
QUANTITY	
DATE	

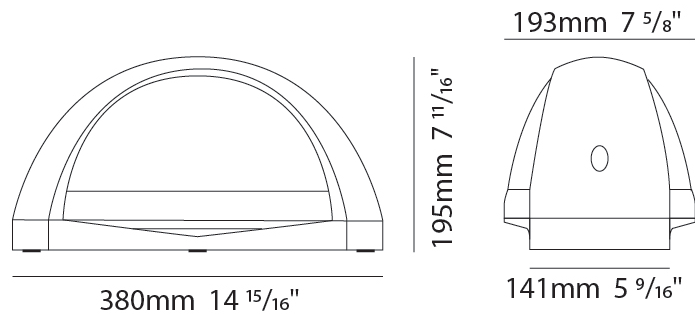

## MISTRAL COLOR FINISH CHART

PROJECT

TYPE

SPECIFIER

QUANTITY

DATE

### Fixture Finish

White - WHI



Black - BLK

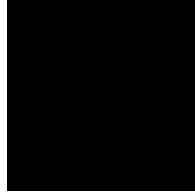

Gray - GRY



**Digital:** Not all screens are calibrated the same, and therefore, colors will appear differently between screens.











**Physical:** When texture is involved, there will be variations in color, character and tone within a product series and between product families.



### LEGEND

 floor-mounted	 pivotable	 special LED (upon request) RGB, RGBW, tunable, gold+, meat+, art+, fashion+
 wall and ceiling: recessed and surface mounted	 rotating	 warm dim / natural dimming LED
 ceiling-mounted and wall-mounted	 illuminate tilted	 rechargeable battery powered
 wall-mounted	 color of suspension cable	 fixture with natural vivid LED (upon request)
 omni-directional light distribution	 length of suspension cable	 color rendering index
 direct light distribution	 reflector degree selection	 color temperature
 direct/indirect light distribution	 super spot	 lumen (luminous flux)
 indirect light distribution	 lens	 efficacy (lumens per watt)
 asymmetric light distribution	 lens pack	 Unified Glare Rating (UGR) range from 5-40
 aura light distribution	 shine ring	 marine grade (AISI 316 stainless steel)
 round wall or ceiling cut-out	 integrated shine ring with diffuser	 walk on
 square wall or ceiling cut-out	 free individual colors 01-29	 drive on
 the supplied jig specifies the cutout dimensions	 individual colors: 00 (free of charge), 01-25 (extra charge)	 Dark Sky Compliance
 minimum distance (meters) lamp - object	 luminaire part to be colored (F1)	 Americans with Disabilities Act (less than 4" off the wall located between 27"-84" from floor)
 recessed depth	 luminaire part to be colored (F2)	 lamp protected against explosion
 ceiling thickness in mm	 luminaire part to be colored (F3)	 blown glass using traditional methods by master glass blower
 ceiling thickness selection	 luminaire part to be colored (F4)	 acoustic material
 dimmable DP (phase), DV (0-10V), DD (dali), DS (step-dim)	 luminaire part to be colored (F5)	 protection class I, protection insulation
 included or excluded LED driver/transformer/control gear	 color of 3-circuit adaptor	 protection class II, protection insulation
 separately switchable	 indirect diffuser	 ETL Certified to UL and CSA Standards
 sensor	 direct diffuser	 UL Certified to UL and CSA Standards
 remote control	 ball-proof (upon request)	 CSA Certified to UL and CSA Standards
 available upon request	 accessory	 Certified for North American Standards

### IP RATING

 IP20	protected against ingress of solid bodies greater than 12.5mm (finger)
 IP33	protected against ingress of solid bodies greater than 2.5mm protected against sprays of water up to 60 degrees from the vertical (rain)
 IP40	protected against ingress of solid bodies greater than 1mm (wire) no protection against the ingress of moisture
 IP43	protected against ingress of solid bodies greater than 1mm (wire) protected against sprays of water up to 60 degrees from the vertical (rain)
 IP44	protected against ingress of solid bodies greater than 1mm (wire) protected against water splashed from all directions
 IP54	protected against limited ingress of dust (wet rooms/covered outdoor areas) protected against water splashed from all directions
 IP65	protected against ingress of dust protected against jets of water
 IP66	protected against ingress of dust protected against powerful jets of water or heavy seas
 IP67	protected against ingress of dust protected against immersion of water between 15cm - 1m for 30 minutes
 IP68	protected against ingress of dust protected against immersion of water under pressure for long periods

### IK RATING

 IK01	protected against 0.14 joules impact (equivalent to 0.25kg mass dropped from 56mm above the surface)
 IK02	protected against 0.2 joules impact (equivalent to 0.25kg mass dropped from 80mm above the surface)
 IK03	protected against 0.35 joules impact (equivalent to 0.25kg mass dropped from 140mm above the surface)
 IK04	protected against 0.5 joules impact (equivalent to 0.25kg mass dropped from 200mm above the surface)
 IK05	protected against 0.7 joules impact (equivalent to 0.25kg mass dropped from 280mm above the surface)
 IK06	protected against 1 joules impact (equivalent to 0.25kg mass dropped from 400mm above the surface)
 IK07	protected against 2 joules impact (equivalent to 0.5kg mass dropped from 400mm above the surface)
 IK08	protected against 5 joules impact (equivalent to 1.7kg mass dropped from 300mm above the surface)
 IK09	protected against 10 joules impact (equivalent to 5.0kg mass dropped from 200mm above the surface)
 IK10	protected against 20 joules impact (equivalent to 5.0kg mass dropped from 400mm above the surface)